

FRAMSIDA/FORSIDE/ETUOSA/FRONT

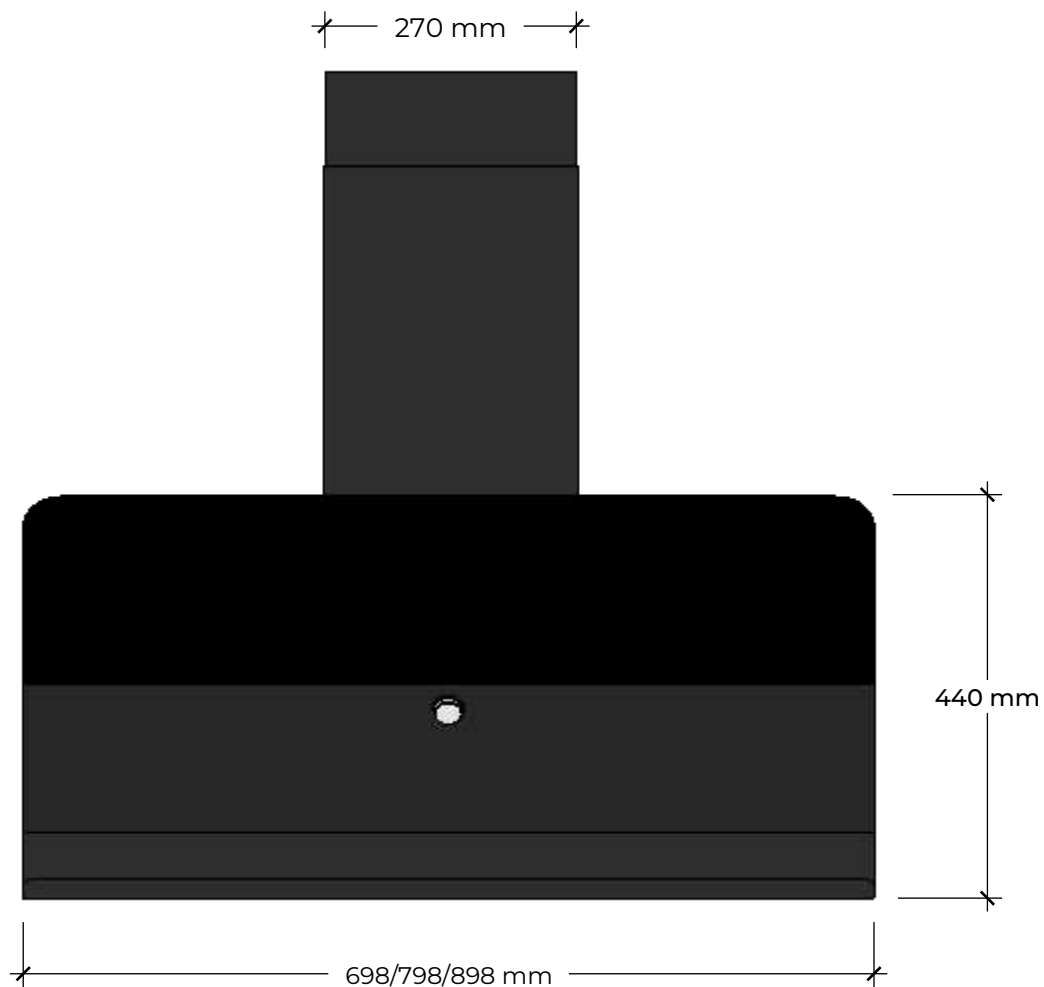

HÖGERSIDA/HØYRE SIDE/OIKEALLA/RIGHT SIDE

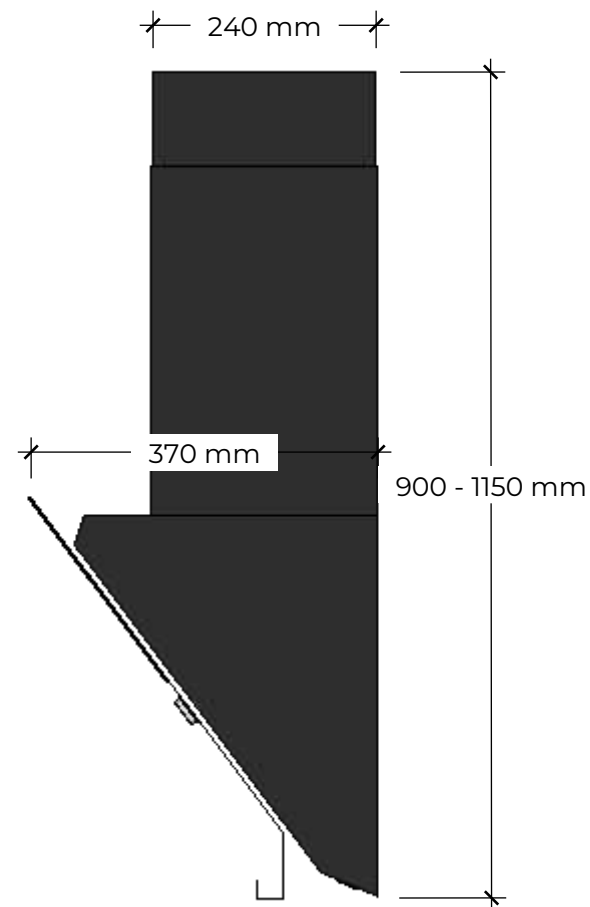

| | |
|-----------|------------|
| Revision: | 0.0 |
| Datum: | 2024-05-28 |

OVANSIDA/TOPP/YLÄKOTELOSSA/TOP

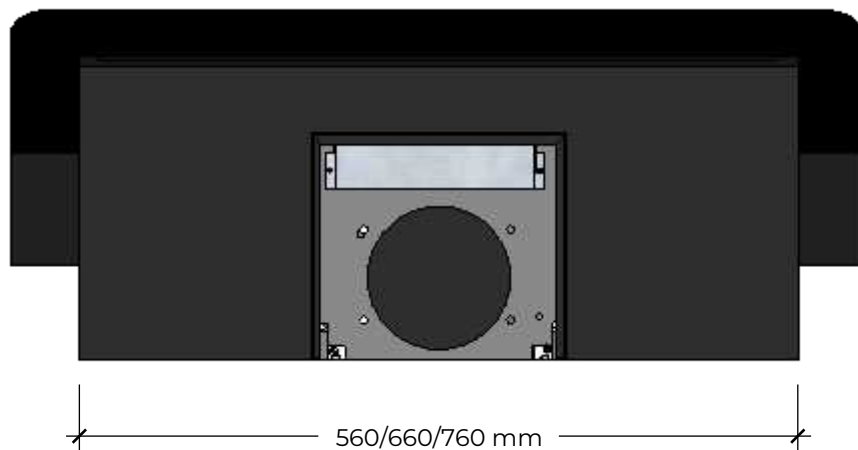

UNDERSIDA/UNDERSIDE/POHJAAN/UNDERSIDE



| | |
|-----------|------------|
| Revision: | 0.0 |
| Datum: | 2024-05-28 |